

*2014 MAZDA3*  
*SMART START GUIDE*

---



# Driver's View



**LIGHTING/  
TURN SIGNALS**  
(P. 23)

**BLUETOOTH®  
HANDS-FREE/  
AUDIO**  
(PP. 11-12, 29-32)

**ACTIVE  
DRIVING  
DISPLAY<sup>1</sup>**  
(P. 15)

**INSTRUMENT  
CLUSTER**  
(PP. 35-38)

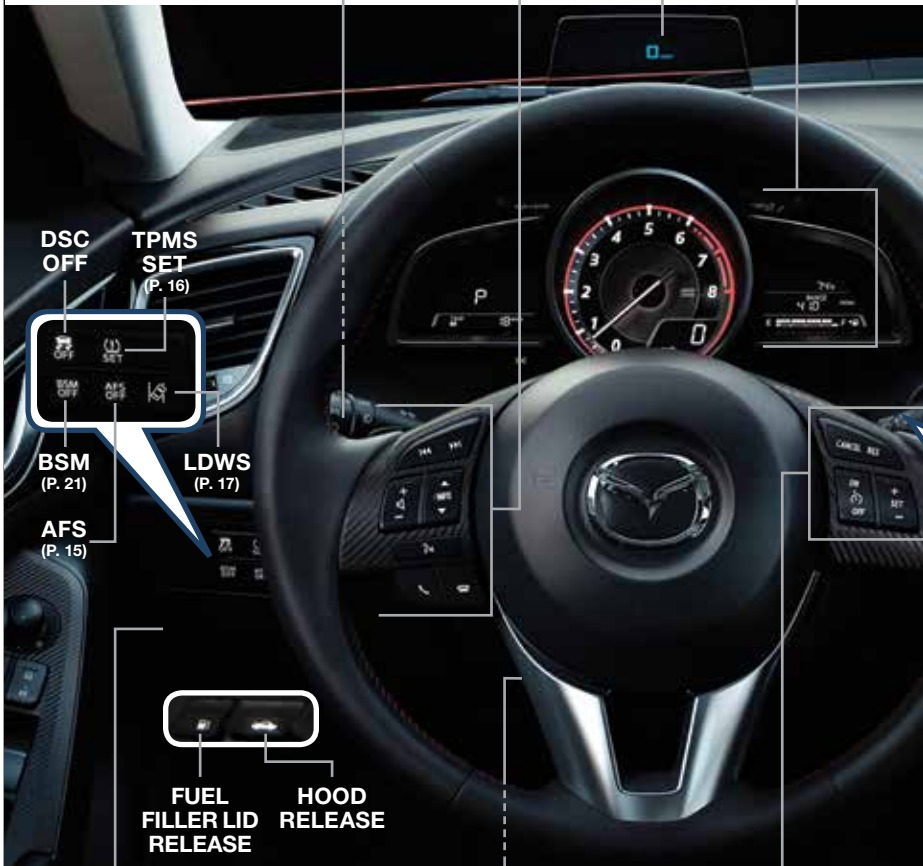

**DSC  
OFF**

**TPMS  
SET**  
(P. 16)

**BSM**  
(P. 21)

**AFS**  
(P. 15)

**LDWS**  
(P. 17)

**FUEL  
FILLER LID  
RELEASE**

**HOOD  
RELEASE**

**TRUNK  
RELEASE  
(4-DOOR)**

**TILT/TELESCOPING  
STEERING WHEEL  
RELEASE LEVER<sup>3</sup>**

**MAZDA RADAR  
CRUISE CONTROL**  
(PP. 17-18)

1

<sup>1</sup> DO NOT try to adjust the angle or open/close the Active Driving Display by hand. Fingerprints on the display will make it difficult to view and manual operation could cause damage. Always adjust the Active Driving Display using the AD-Disp tab in Settings (pg. 16).

<sup>3</sup> To provide a better view of the instrument cluster, adjust the steering wheel up or down/in or out.



**WIPER/  
HAZARD  
WARNING**  
(P. 24)

**HAZARD  
WARNING**

**MAZDA CONNECT  
INFOTAINMENT  
SYSTEM**  
(PP. 9-10, 16, 13-14, 31-33)

**CLOCK**  
(P. 29)

**PASSENGER  
AIRBAG OFF  
INDICATOR<sup>2</sup>**



**START/STOP  
ENGINE BUTTON**  
(PP. 5-6)



**AUDIO SYSTEM  
(WITHOUT  
INFOTAINMENT)**  
(PP. 29-30, 33)

**CLIMATE CONTROL**  
(PP. 27-28)

**TRANSMISSION**  
(PP. 39-40)

**CD  
PLAYER**

**SEAT  
WARMERS**

<sup>2</sup> **PASS AIRBAG OFF** This indicator light illuminates to remind you that the front passenger's front/side airbags and seat belt pretensioner will not deploy during a collision. The reason for this is that the weight in the seat is less than approximately 66 lbs. Always wear your seat belt and secure children in the rear seats in appropriate child restraints. See the Owner's Manual for important information on this safety feature.

**NOTE:** Indicator light turns off when conditions have been met for necessary airbag deployment. See Owner's Manual for further information.





## KEYLESS ENTRY SYSTEM

- This system allows you to lock and unlock the doors by pushing the desired buttons.

### Unlock

- Push once to unlock driver's door or all the doors (depending on personalization setting\*).
- Push twice (within three seconds) to unlock all doors.

### Panic Alarm

- Push for one second or more to activate alarm.
- Push Lock, Unlock, or Panic Alarm to turn alarm off.



### Lock

- Push once to lock all doors.
- Push twice (within five seconds) for horn sound verification that all doors are locked.

### Trunk (4-door sedan only)

- Push and hold to open the trunk.

**NOTE:** For the hatchback, when the liftgate opener switch is pushed, the liftgate will open slightly. If the liftgate is not opened within 1.5 seconds, the liftgate latch locks (you will hear it lock) and the liftgate cannot be opened or closed from this slightly raised position. To open/close the liftgate, push the liftgate opener switch, open the liftgate within 1.5 seconds, then close it. The door/liftgate ajar warning light will be on if the liftgate is not fully closed.

### CAUTION:

- Make sure vehicle is OFF and take the keyless entry system key with you when leaving the vehicle.
- When locking doors using inside door switches or inside door-lock knobs, be careful not to leave the key inside the vehicle.

**NOTE:** With Advanced Keyless, there is a recognizable beep sound to alert you that the key is inside the vehicle.

### Inside Door Lock Switch

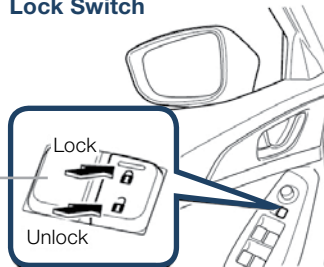

**CAUTION: RED**  Key Indicator Light may illuminate if either advance key or keyless entry key is placed in the cup holder. The key can sometimes not be detected in the cup holder.



## ADVANCED KEYLESS ENTRY SYSTEM (if equipped)

- This system allows you to lock and unlock the doors without taking the key out.

### While Carrying the Advanced Key...

- **Unlock the driver's door** by pushing the driver's door request switch once.
- **Unlock all doors** by pushing the driver's door request switch once or twice (depending on personalization setting) OR by pushing the passenger's door request switch once.
- **Lock all doors** by pushing any request switch once.
- **Open the trunk/liftgate** by pushing the opener switch once (switch is located a little to the right of the Mazda emblem).

### Advanced Key

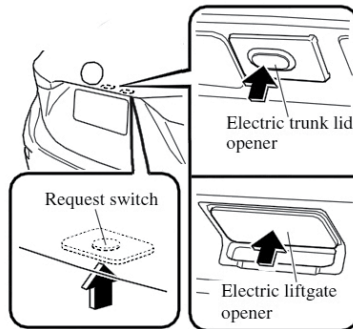
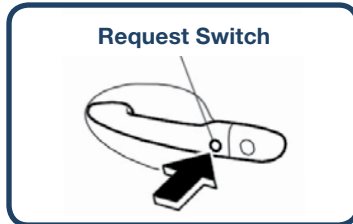

### NOTE:

- Vehicles equipped with the Advanced Keyless Entry System and the Keyless Entry System both use the same type of keyless entry transmitter. However, only vehicles equipped with the Advanced Keyless Entry System allow you to lock and unlock the doors with the door request switches (without taking the key out of your purse or pocket).
- Vehicles equipped with the Keyless Entry System do not have request switches on the doors/trunk. To lock and unlock the doors, the corresponding transmitter button must be pushed.





## STARTING THE ENGINE WITH ACCELERATED WARM-UP SYSTEM (AWS)

*The Mazda3 is equipped with SKYACTIV combustion technology. This technology includes AWS (Accelerated Warm-up System) for optimal emission performance during cold starting conditions.*

### While Carrying the Key...

- **Start the engine** by pushing the START/STOP ENGINE button while pushing the clutch pedal (M/T) or the brake pedal (A/T).

**What you will notice?** On start-up, the engine speed and sound are higher (1500 RPM) for less than 1 minute to quickly bring the catalyst to efficient operating temperature. The RPM will reduce to idle once the temperature is achieved. This is normal engine operation under cold start conditions.

**What this does?** This heats up the catalytic converter faster to reduce emissions and allows Mazda to use an exhaust header on the engine (to improve efficiency and horsepower).

**NOTE:** You can drive the vehicle during AWS activation, no need to wait.

- **Shut the engine OFF** by setting the parking brake/placing the vehicle in Park (A/T), then push the START/STOP ENGINE button.
- **Activate Accessories (ACC)** by pushing the START/STOP ENGINE button once without pushing the clutch or brake pedal.
- **Turn the ignition to the ON position** by pushing the START/STOP ENGINE button twice without pushing the clutch or brake pedal.

The key indicator light  in the instrument cluster will show **GREEN** (engine ready to start) when the key is detected and the clutch pedal (M/T) or the brake pedal (A/T) is pushed. If the KEY warning light illuminates **RED**, or the START/STOP ENGINE button indicator light flashes **AMBER**, this could indicate a problem with the engine starting system and the inability to start the engine or switch the ignition to ACC or ON. Have your vehicle inspected at an Authorized Mazda Dealer as soon as possible.

**NOTE:** **RED**  Key Indicator Light may flash if the key is placed in the cup holder. The key may not be detected in the cup holder.



## Emergency Engine Stop

Pushing and holding the START/STOP ENGINE button or repeatedly pushing the button while the engine is running will turn the engine OFF. Use only in case of an emergency.

## Emergency Vehicle Entry

If the key cannot be used due to a malfunction or dead key battery, use the auxiliary key to lock or unlock the doors.

## Emergency Engine Start

If the engine cannot be started due to a dead key battery:

- 1 Push the brake pedal (A/T) or the clutch pedal (M/T).
- 2 While the indicator light flashes **GREEN**, touch the START/STOP ENGINE button using the back side of the transmitter (as shown).
- 3 After the **GREEN** indicator light illuminates constantly, push the START/STOP ENGINE button with your finger to start the engine.

## BREAK-IN PERIOD

No special break-in is necessary, but a few precautions in the first 600 miles should be observed.

- Do not race the engine.
- Do not maintain one constant speed, either slow or fast, for a long period of time.
- Avoid full-throttle starts.
- Avoid unnecessary hard stops.
- Do not drive constantly at full-throttle or high engine rpm for extended periods of time.



Key (Rear)



Auxiliary Key Release

## FUEL ECONOMY:

To achieve the best fuel economy, visit [www.fueleconomy.gov](http://www.fueleconomy.gov) for more information.







## TIRE PRESSURE MONITORING SYSTEM (TPMS)

**For your safety, the Mazda3 is equipped with TPMS that detects low tire pressure in one or more tires. If the tire pressure starts getting low in one or more tires, the system alerts the driver by turning on a light in the instrument cluster (p. 35-38) and sounding an alarm.**

**What to do?** Don't ignore the TPMS warning light. Stop and check your tire pressure (when tires are cold) and inflate them to the proper pressure. Properly inflated tires are safer, last longer, and increase fuel economy.

**In the following cases, the TPMS must be “initialized” so the system can operate normally.**

- The tire pressure is adjusted (up or down) in one or more tires.
- A tire rotation is performed.
- Any tire or wheel is replaced.
- The vehicle's battery is disconnected, replaced or completely dead.

### Initialization Process (TPMS Warning Light is Illuminated)

- 1 Park the vehicle in a safe place and firmly apply the parking brake.
- 2 Let the tires cool, then adjust the tire pressure to the specified pressure (See tire label located on the driver's side door jam area) on all four (4) tires.
- 3 Switch the ignition ON, but leave the vehicle parked.
- 4 Push and hold the TPMS “Set Switch” (left side of dash) until the TPMS warning light  in the instrument cluster flashes twice and a beep sound is heard once.



**CAUTION:** If the TPMS “Set Switch” is pushed without adjusting the tire pressure, the system cannot detect the normal tire pressure. The TPMS warning light may not turn on, even if the tire pressure is low, or it may turn on if the tire pressure is normal.

**NOTE:** Drastic changes in temperature or altitude may cause the TPMS warning light to turn on.



# Seats and Headrests

## FRONT SEATS

### Headrests

For your safety, the front seats are equipped with active headrests that are not adjustable forward or backward, only up and down. An active headrest is designed to move forward in the event of a collision to close the gap between your head and the headrest (to prevent whiplash).

### Driver's Seat Lumbar Support Adjustment (if equipped)

To increase the lumbar support, move the lever upward. Move the lever downward to decrease lumbar support.



## REAR SEATS

### Folding rear seatbacks down: 4-door sedan

- 1 Check that rear seats are clear of objects.
- 2 Open the trunk and pull the left and/or right side remote handle lever(s).
- 3 Open a rear door and fold the seatback forward.



**NOTE:** Left rear seat release is shown.

### 5-door hatchback

Push the button to fold down the seatback.

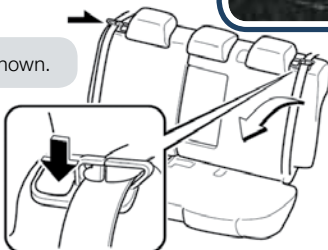

**NOTE:** For tall drivers and front passengers who adjust the front seats all the way back, the headrests on the rear seats need to be removed when folding the rear seatbacks down. If not removed, the rear headrest will press into the front seatback. In order to remove the headrest from the rear seat, the seatback needs to be tilted slightly forward.

### Returning rear seats to upright position:

- 1 Install the headrest (if removed).
- 2 Raise seatbacks until they lock into position.
- 3 Pull on the top of the seatbacks to make sure they are locked.
- 4 Check that all seat belts are routed properly for passenger use.



# Mazda Connect Infotainment System

## MAZDA CONNECT INFOTAINMENT SYSTEM (if equipped)

**Mazda Connect is designed to be operated by using one of the following three interfaces:**

- 1 The commander switch (p. 10).
- 2 The touchscreen (if the vehicle is not moving).
- 3 Voice control (p. 10).

**TALK**



### NOTE:

- In the interest of safety and to avoid distracted driving, the touchscreen is disabled at speeds over 5 mph. Use the commander switch or voice control to operate the infotainment system.
- You can touch and tap, slide or swipe the touchscreen, but cannot pinch.



# Commander/Voice Control

## COMMANDER SWITCH (if equipped)

**The commander is the primary means for operating Mazda Connect. It allows you to keep your head up and eyes on the road.**

The control places five buttons naturally beneath the five fingers and shows five matching icons on the home screen for touch-only operation. Select a button around the commander knob to operate the desired system.

### AUDIO

### BACK

(to previous screen)



### HOME

### NAVIGATION

**MUTE** (push down)/  
**VOLUME** (turn dial)

### FAVORITES

The following can be stored in Favorites:

- 50 stations total for AM, FM, and XM.
- 50 contacts in the system phonebook.
- 50 points of interest in navigation. (To edit or delete HOME, select HOME and push and hold the commander knob until the Edit/Delete HOME screen appears.)

### Select an item on the screen by:

- 1 Moving the knob up or down, left or right, and/or turn the dial to move the cursor to the desired on-screen location (and get a description of the icon).
- 2 Pushing the knob down (ENTER) to select your choice on the screen.

## VOICE CONTROL (if equipped)

Voice control is activated by pressing the TALK button on the steering wheel and speaking a command. Voice commands usually contain a verb (action word) followed by a noun. Common verbs are “Go to” and “Play”.

### SOME COMMON VOICE COMMANDS ARE:

- Help
- Cancel
- Go Back or Previous
- Next or Skip
- Tutorial
- Scroll/Page Down
- Scroll/Page Up
- Turn Display/Screen Off
- Select <line number> (ex: “Select Four” or “Select Line Four”)
- Display Clock

### Go to (and one of the following):

- Home
- Entertainment
- Navigation
- Communication
- Settings
- Messages
- Contacts
- Email
- Phone
- Call History
- Text
- AM/FM
- XM
- CD
- Bluetooth
- AUX
- USB
- Pandora
- Aha
- Stitcher

### Play (and one of the following):

- AM/FM
- XM
- CD
- Bluetooth
- AUX
- USB
- Pandora
- Aha
- Stitcher
- Song
- Playlist
- Artist
- Album
- Genre
- Folder

## PAIRING YOUR BLUETOOTH® PHONE OR AUDIO DEVICE

### NOTE:

- For safety reasons, you cannot pair a phone while driving.
- Before pairing your cell phone or audio device, you must manually turn on the device's Bluetooth® function. Refer to the owner's manual for your device.
- **For customer service and device compatibility:**  
**Toll-free call: 800-430-0153**  
**Website: [www.MazdaUSA.com/bluetooth](http://www.MazdaUSA.com/bluetooth)**
- **IMPORTANT:** Set the volume level on your cell phone or audio device to the highest level before distortion starts, then adjust the volume on the vehicle's audio system.
- When in range of another Wi-Fi device, the Bluetooth connection between your phone and the system may disconnect for a short time if you have Wi-Fi enabled. Turn off Wi-Fi on your phone if needed.



### Without Mazda Connect:

- 1 Manually turn Bluetooth on your phone or audio device.
- 2 Push and release the TALK button on the steering wheel (wait for beep).
- 3 From main menu, say, "Setup," then "Pairing Options."
- 4 Say, "Pair."
- 5 Say a four-digit code (i.e., "1, 2, 3, 4").
- 6 Place phone in discovery mode; if necessary, consult your phone's manual or go to [www.mazdausa.com/bluetooth](http://www.mazdausa.com/bluetooth). Select model, Bluetooth, and follow screen prompts.
- 7 After phone is recognized, you will be prompted to name the paired phone.



### With Mazda Connect:

- 1 Manually turn Bluetooth on your phone or audio device.
- 2 Select Communication from Home screen.
- 3 Select Settings.
- 4 Select Bluetooth.
- 5 Select Add New Device to display the message and switch to the device operation. If this option is grayed out, make sure Bluetooth is turned on at the top of the menu.
- 6 Using the device, perform a search for the Bluetooth® device (Peripheral device).
- 7 Select "Mazda3" from the device list searched by the device. (Device with Bluetooth® version 2.0) Input the displayed 4-digit pairing code into the device. (Device with Bluetooth® version 2.1 or higher.)
  - Just Works is detected the pairing is performed automatically.
  - Numeric Comparison is detected
- 8 Verify the displayed 6-digit code on the audio unit is also displayed on the device, and touch the Yes on-screen button and then "YES" on the device if needed.





**For phone's compatible with Email, SMS and MMS:**

- 9 (Call History) Incoming/Outgoing history for the device is downloaded automatically as well as your Phonebook.
- 10 (Devices compatible with Mazda Email/SMS function) SMS (Short Message Service) messages, MMS (Multimedia Message Service) messages, and Email for the device are downloaded automatically. Permission may be required, depending on the mobile device.

**TO MAKE OR RECEIVE A HANDS-FREE CALL**

 **button:** To receive/swap a call.

 **button:** To make a call (push and say "Phone") or to skip vehicle voice guidance and allow user to speak next voice command.

 **button:** To end/reject a call.

**Automatic Bluetooth Reconnection:**

On engine start, the last connected device will automatically be re-connected after several seconds. To switch phones, go to Device Settings and select Bluetooth.











**NOTE:** For connection issues, please confirm the Bluetooth connection status by making sure there is cell phone icon on the audio display (without infotainment) or by making sure there is a battery and signal strength icon in the top right corner of the screen (with infotainment). Some phones will turn off the Bluetooth signal after connecting the USB cable to the vehicle or after downloading an update.

- If not displayed, check your phone and make sure Bluetooth is turned on (or discoverable) in the Settings menu. Detailed instructions for some phones are available online.
- If there is still no connection, delete the pairing data on the system and your phone and try again after confirming your cell phone is compatible at [www.MazdaUSA.com/bluetooth](http://www.MazdaUSA.com/bluetooth).

**NOTE:** Some phone models do not support all features. If your phone or device does not pair, please visit [www.MazdaUSA.com/bluetooth](http://www.MazdaUSA.com/bluetooth) or contact (800) 430-0153 for further assistance or to report a phone/audio device concern.

**The following icons are displayed on the touchscreen during a call:**

- |  |  |  |
|--|--|--|
|  Displays the Communication screen.                    |  Calls another person during a call and creates a 3-way call. Select the contact from one of the following: Call History, Contacts (from phonebook), or Dial (from numerical keypad). |  Switches the call on hold. |
|  Ends a call.  |  Allows transmitting DTMF (Dual Tone Multi-Frequency) signal via the numerical keypad (generally to a home telephone answering machine or an automated guidance call center).         |  |
|  Transfers a call from hands-free to the mobile phone. |  |  |
|  Transfers a call from the mobile phone to hands-free. |  |  |
|  Mutes the call.                                       |  Joins the call on hold to make a 3-way call.   |  |

# Navigation System

## NAVIGATION SYSTEM (if equipped)

### Planning A Route

#### IMPORTANT:

- In the interest of safety and to reduce distractions while you are driving, you should always plan a route before you start driving.
- To adjust the volume of the navigation system voice while driving, adjust the volume by turning the VOL knob when voice guidance is being given. To prompt voice guidance, push the NAVI button to repeat the last instruction.



ICON	Voice Control	Purpose
	<b>Hide/Show Menu Bar</b>	To open and close the Menu bar.
	<b>Enter Destination</b>	To enter an address or favorite destination, or select a place of interest or a location on the map.
	<b>Navigation Information</b>	To switch to the navigation information screen on which items such as traffic information and GPS reception conditions.
	<b>Cancel</b>	To cancel an existing way point/route.
	<b>Point of Interest</b>	To find places nearby.
	<b>Route Options</b>	To display the route parameters and full length of route. Perform route-related actions such as edit or cancel, pick route alternatives, avoid parts, add destination to Favorites.
	<b>View Mode</b>	To change the map mode (2D north up / 2D heading up / 3D).
	<b>Settings</b>	To adjust the navigation settings.

To plan a route on your Navigation system, do the following:

- 1 Push the **NAV** button on the commander switch.
- 2 Select **NEW DESTINATION**.
- 3 Select **Find Address**.

**NOTE:** By default, the navigation system detects the country and city/town you are in. If needed, you can change the country or state setting by selecting **Country** or a new city/town by selecting **City or Zipcode**.

- 4 Enter the street name.
- 5 Enter the house number, then select the ✓.
- 6 The system transitions to a screen where the input location can be checked. To transition to the next screen, select ✓  
**Select** or to transition to the previous screen, select ↶.



**NOTE:** Select **Places Nearby** for POIs (points of interest) around the selected location, or select **Add to Favorites** to register the selected location to Favorites.

**NOTE:** The route can be edited by selecting other options.

- 7 If **Go** is selected or if no operation is performed with 10 seconds, the route guidance is started. The set route can be checked by selecting **MAP**.

## Planning A Route Using Voice Commands

You can navigate to any of the following places using your voice:

- AN address, **including home**
- **Favorites**
- Cities and towns
- POI (Point of Interest) categories
- POIs for named brands of, for example, restaurants, gas stations, car rental and gyms.
- A recent destination

**NOTE:** POI searches for points of interest near your present location.

To plan a route to an address using your voice, do the following:

- 1 Push the **TALK** button on the steering wheel.
- 2 When you hear the tone, you can say, for example “Drive to an address”.
- 3 Say the full address (without zip code) for your destination, for example “123 Main St., Los Angeles, California”. The system does not recognize zip codes.

**NOTE:**

- For best results, say the full address without pausing between words.
- Voice guidance can be skipped by pushing the talk button.

- 4 Say “Yes” if the address is correct. If shown a list of addresses, say the list number for the correct address or say “none of these”.

## To remove or insert the MAP SD card (to update the map database):

**NOTE:**

- Visit [www.mazdausa.com/navigation](http://www.mazdausa.com/navigation) and download the most recent map available for your device for free for 3 years from vehicle delivery. Please refer to the Navigation System Owners Manual section of [www.mazdausa.com/navigation](http://www.mazdausa.com/navigation) for additional information.
- Only use your MAP SD card for operating and updating your navigation system. Do not insert the MAP SD card into another vehicle or into any other device such as a camera.
- Do not put other SD cards in this slot.

- 1 Turn the vehicle ignition OFF.
- 2 Locate the SD card slot inside the center console.
  - Remove card: Open the cover and push the card once, then pull it out.
  - Insert card: Push the card in (label-side up), then close the cover.





# Active Driving Display

## ACTIVE DRIVING DISPLAY (if equipped)



**CAUTION:** Always adjust the display using the Settings screen (AD-Disp tab). Do not try to adjust the angle or open/close the display by hand. Fingerprints on the display will make it difficult to view and manual operation could cause damage.

The Active Driving Display displays the following information:



- **Vehicle Speed Setting** using cruise control



- **Navigation Turn-by-Turn (TBT)** direction, distance and lane guidance



- **Lane Departure Warning System (LDWS)** operation conditions and warnings



- **Smart City Brake Support (SCBS)** warnings



- **Vehicle Speed Setting** using cruise control (if equipped)

To change the settings/adjustments for the Active Driving Display:

- 1 Select the Settings icon on the Home screen.
- 2 Select the AD-Disp tab.
- 3 Select the desired item to change.
  - **Height:** Adjust the position of the virtual image of the Active Driving Display up or down.
  - **Brightness Control:** Method for adjusting screen brightness (Automatically with instrument cluster illumination or manually).
  - **Calibration:** Brightness initialization setting (when selecting automatic adjustment).
  - **Brightness:** Brightness adjustment (when selecting manual adjustment).
  - **Navigation:** On/Off.
  - **Active Driving Display:** On/Off.
  - **Reset:** Reset to default settings.

### NOTE:

- If the display does not operate, switch the ignition off and then switch it back on. If it still does not operate even with the ignition switched ON, have the vehicle inspected at an Authorized Mazda Dealer.
- It may be difficult to view the display when wearing sunglasses. Take off your sunglasses or adjust the luminosity.
- If the battery has been removed and re-installed or the battery voltage is low, the adjusted position may deviate.
- The display may be difficult to view or temporarily affected by weather conditions such as rain, snow, light, and temperature.

# Mazda Connect Settings

## MAZDA CONNECT SETTINGS (if equipped)

### To view the different setting screens:

- 1 Move the commander switch to the left or right to change tabs.
- 2 When the desired tab is highlighted, press the knob of the commander switch down.
- 3 Turn the dial of the commander switch to scroll down the list.

**NOTE:** If there is a scroll bar on the right side, there are more items further down.

### Display Settings



Use **System** to change the brightness of the Display between Day (bright), Night (dim), and AUTO (switches from Day to Night when headlights are turned ON).

### Active Driving Display Settings



### Safety Settings

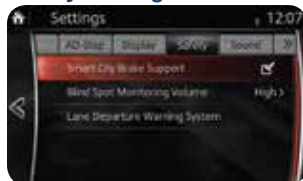

### Sound Settings



### Device Settings

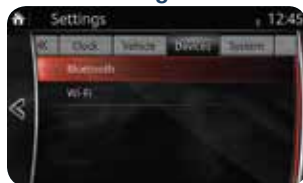

### Vehicle Settings

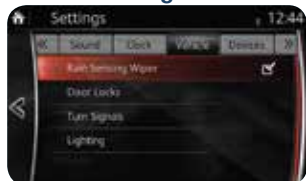

### System Settings





# Mazda Radar Cruise Control

## MAZDA RADAR CRUISE CONTROL (MRCC) SYSTEM (if equipped)

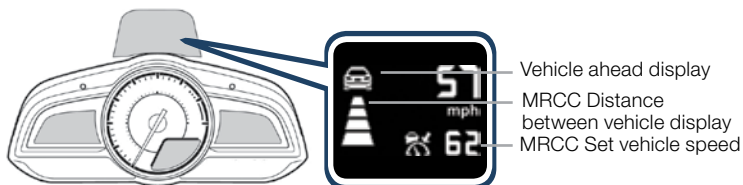
The MRCC system maintains vehicle speed and following distance using a radar sensor to detect a vehicle ahead. The driver simply presets the vehicle speed between 19 mph (30 km/h) and 90 mph (145 km/h) and the system will maintain a safe following distance without having to turn the cruise control off.



The system operates in two modes, Constant Speed and Headway Control modes:

<b>Constant Speed Mode</b> When no vehicle is detected ahead, the driver's set speed is maintained.	<b>Headway Control Mode</b> When a vehicle is detected ahead, a distance between your vehicle and the vehicle ahead is maintained.
	

### Setting the MRCC

When the ON switch is pushed, the vehicle speed and the distance between vehicles while in headway control can be set. The MRCC indication is shown in the display of the instrument cluster.

**NOTE:** The radar for the MRCC is located behind the Mazda emblem in the grill. Keep this area clean to avoid the system not working properly.

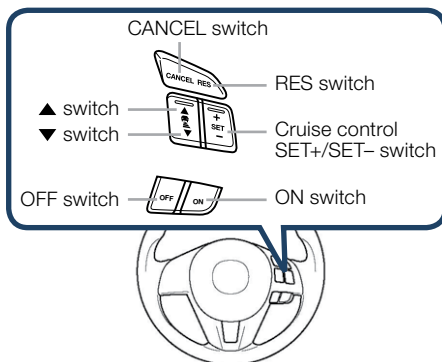

# Forward Obstruction Warning

## How to set the speed:

- 1 Adjust the vehicle to the desired speed using the accelerator pedal.
- 2 Push the SET + or SET - switch. The set speed and the inter-vehicle distance display filled with white lines is displayed in the active driving display and the MRCC indicator light (green) turns on simultaneously.

Travel Status	During travel at constant speed	During travel under headway control
Display		

## How to set the distance between vehicles:

The distance between vehicles is set to a shorter distance by pushing the ▲ switch a longer distance by pushing the ▼ switch. The distance-between-vehicles can be set to 4 levels.

Distance between vehicles guideline (at 50mph (80km/h))	Long (about 164ft (50m))	Medium (about 131ft (40m))	Short (about 98ft (30m))	Extremely short (about 82ft (25m))
Display				

**CAUTION:** Do not rely completely on the MRCC system and always drive carefully obeying the speed limit.

**NOTE:** The MRCC sometimes will brake your vehicle when passing a semi truck (tractor trailer). This is normal. Simply press the accelerator pedal to override the system.

## FORWARD OBSTRUCTION WARNING (FOW)

*The Forward Obstruction Warning (FOW) system alerts the driver of a possible collision using an indicator in the active driving display and instrument cluster along with a warning sound.*

*The system operates when driving at 10 mph (15 km/h) or faster and the system's radar sensor determines that your vehicle may hit a vehicle or obstruction ahead.*

**BRAKE!**

**NOTE:** FOW can be turned off using the DSC OFF button.

**WARNING:** FOW is only a supplementary system designed to reduce damage in the event of a collision. The FOW has limitations and does not detect all objects. Do not rely solely on the FOW. Relying solely on the FOW may cause an unexpected accident resulting in death or serious injury. Always keep your eyes on the road.

# Smart City Brake Support

## SMART CITY BRAKE SUPPORT (SCBS) SYSTEM (if equipped)

*The SCBS system is designed to reduce damage in the event of a collision by applying the brakes when the system's laser sensor detects a vehicle ahead. The system operates when the vehicle speed is 2 to 18 mph (4 to 30 km/h) and the system determines that a collision with a vehicle ahead is unavoidable.*

### NOTE:

- It may be possible to avoid a collision if the relative speed between your vehicle and the vehicle ahead is less than 9 mph (15 km/h).
- When the driver depresses the brake pedal while the system is in the operation range between 2 to 18 mph (4 to 30 km/h), the brakes are applied firmly and quickly to assist. (SCBS Automatic Brake is displayed in the active driving display.)
- SCBS automatic brake is released approximately 2 seconds after the vehicle comes to a stop.
- Refer to your Owner's Manual for complete details.

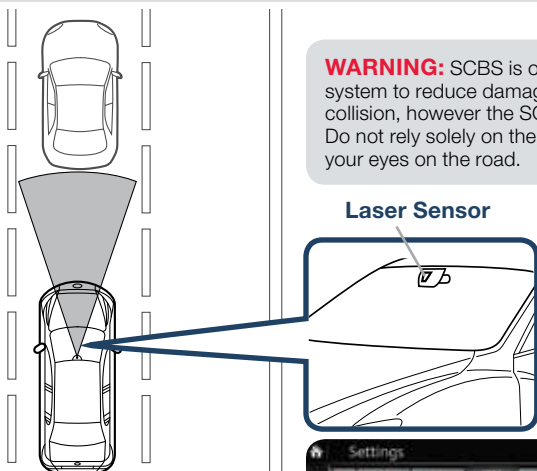

**WARNING:** SCBS is only a supplementary system to reduce damage in the event of a collision, however the SCBS has limitations. Do not rely solely on the SCBS. Always keep your eyes on the road.







**NOTE:** SCBS system can be turned off using Safety Settings in the infotainment system.



# Lane Departure Warning System

## LANE DEPARTURE WARNING SYSTEM (LDWS) (if equipped)

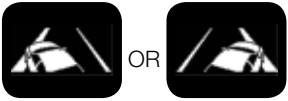
The LDWS recognizes painted lane lines on a road using the forward sensing camera (FSC) installed to the windshield. If the vehicle deviates from its lane at speeds above 44 mph, the system alerts the driver using the following indicators.

Indicator Light	Active Driving Display	Condition
		The painted lane lines on the road are not recognized or the vehicle speed is less than 44 mph
		The painted lane lines are recognized at vehicle speeds of 44 mph or more
 Flashes + warning sound		Warning is triggered when vehicle deviates from its lane
No indicator light		LDWS OFF

**NOTE:** Any driver input (e.g., turn signal, steering or acceleration) will cancel warning.

**WARNING:** LDWS is only a supplementary system to warn the driver that the vehicle may be deviating from its lane, however the LDWS has limitations. Do not rely solely on the LDWS. Relying solely on the LDWS may cause an unexpected accident resulting in death or serious injury. Always pay attention to the direction in which the vehicle is traveling and drive safely.



Use the LDWS switch to turn system ON or OFF

# Blind Spot Monitoring System

## BLIND SPOT MONITORING (BSM) (if equipped)

**The BSM system is designed to assist the driver by monitoring blind spots on both sides of the vehicle to the rear in certain situations such as when changing lanes on roads and freeways.**

### Turning BSM System Off

Turning the BSM system off will turn off both the light and sound indicators. To manually turn the BSM system off, push the BSM OFF switch on the dash.

The BSM OFF indicator in the instrument cluster will turn on to indicate when the BSM system is off. The BSM system will automatically turn on the next time the vehicle is started.

- If your vehicle speed is 7 mph (11 km/h) or more, the BSM will warn you of vehicles in the detection area by illuminating the BSM warning lights located on the left and right door mirrors.
- If you operate a turn signal in the direction of an illuminated BSM warning light, the system will also warn you with a beep and warning light flash.
- BSM sensors are located under the left and right rear bumper areas. The BSM system may not operate properly if the rear bumper gets dirty, so keep the rear bumper area clean and free of bumper stickers.



### Your Vehicle

Refer to your Owner's Manual for complete details.

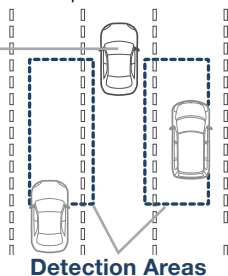

### NOTE:

- The BSM can assist the driver in confirming the safety of the surroundings, but is not a complete substitute.
- The driver is responsible for ensuring safe lane changes and other maneuvers.
- Always pay attention to the direction in which the vehicle is traveling and the vehicle's surroundings.
- The BSM does not operate when the vehicle speed is lower than about 7 mph (11 km/h).

**WARNING:** BSM is only a supplementary system to help aid in monitoring blind spots, however BSM has limitations. The system may not detect all vehicles, especially a motorcycle. Do not rely solely on the BSM. Relying solely on the BSM may cause an unexpected accident resulting in death or serious injury. Make sure to look over your shoulder before changing lanes.



# Rear Cross Traffic Alert

## REAR CROSS TRAFFIC ALERT (RCTA) (if equipped)

**The RCTA is designed to alert the driver of oncoming traffic when backing out of a parking spot. RCTA is active when your vehicle is in reverse and your vehicle speed is 0 to 8 mph (13 km/h).**

When BSM sensors detect an object moving 3 to 18 mph (5 to 30 km/h), RCTA will notify the driver with indicators and sound:

- Rear View Monitor and outside mirror flashing indications.
- Beep sound (same as BSM).

Refer to your Owner's Manual for complete details.



Settings button for rear view monitor.

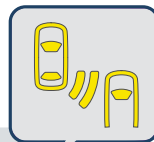

**WARNING:** RCTA is only a supplementary system to help aid when backing up, however RCTA has limitations. The system does not detect all vehicles, especially a motorcycle. Do not rely solely on the RCTA. Relying solely on the RCTA may cause an unexpected accident resulting in serious injury. Always back up slowly.

## LIGHTING CONTROL/TURN SIGNAL LEVER

: Turns tail, parking, and dashboard lights on.

**AUTO:** The light sensor automatically determines when to turn the headlights on or off.

: Turns fog lights on only when headlights are on.

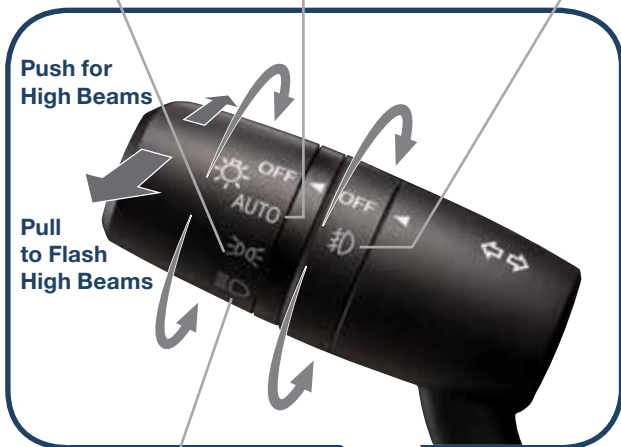

: Turns tail, parking, dashboard, and headlights on.

**Three-Flash Turn Signal:** To signal a lane change, push the turn signal lever up or down halfway and release. The turn signal indicator will flash three times.

### HEADLIGHT LEVELING (without AFS)

Adjust headlight angle with headlight leveling switch depending on vehicle passengers and load (example: Driver only = 0, Driver + Passengers = 1 or 2, etc.). Refer to your Owner's Manual for complete details.



**NOTE:** The DRL (Daytime Running Lights) automatically turn on when the ignition is switched ON. To disable/enable this feature see your Authorized Mazda Dealer.

### NOTE:

- You can adjust the timing of the Auto Headlights OFF and the sensitivity of the Auto Light Control.

## WINDSHIELD WIPER/WASHER CONTROL LEVER

**AUTO:** The rain sensor senses the amount of rainfall and turns the wipers on or off. Rotate inner ring away from you (clockwise) for more (+) sensitivity (requires less rain to turn wipers on) and toward you (counterclockwise) for less (−) sensitivity (requires more rain to turn wipers on).

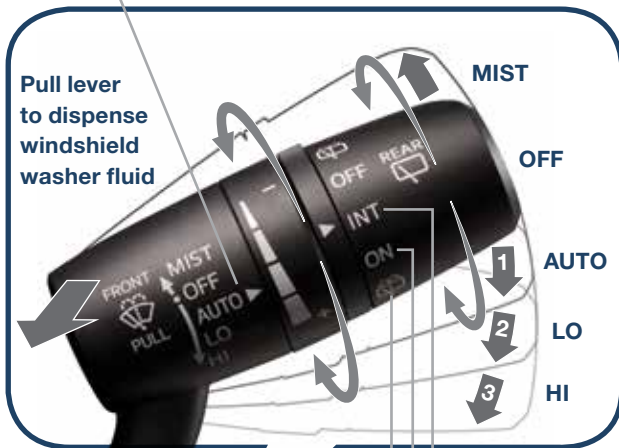

### Rear Window Wiper/Washer (Hatchback)

**INT:** Intermittent

**ON:** Normal speed

 Washer/wiper (hold as desired)

**NOTE:** Vehicles not equipped with AUTO wipers will have INT wipers. Set the lever to INT and choose an interval timing by rotating the ring between fast and slow.

**CAUTION:** If the ignition is ON, turn the AUTO wipers OFF when going through a car wash, or while cleaning or touching the windshield.

# High Beam Control

## HIGH BEAM CONTROL (HBC) (if equipped)

**With HBC, the headlights are switched to high beams at speeds above 18 mph (30 km/h) when there are no vehicles in front of your vehicle or approaching in the opposite direction.**

### The HBC system switches to low beam when:

- You are approaching a vehicle or a vehicle is approaching in the opposite direction.
- Driving on roads lined with street lights or well-lit cities and towns.
- At speeds lower than 12 mph (20 km/h).

### To turn HBC on:

- 1 Turn the headlight switch to the AUTO position.
- 2 Push the headlight lever forward to the High Beam position.

FORWARD



When the HBC system is on, the HBC indicator light in the instrument cluster will illuminate (GREEN). The High Beam indicator light will turn on (BLUE) when the HBC system switches to high beam and will turn off when the HBC system switches to low beam.



# Adaptive Front Lighting System

## ADAPTIVE FRONT-LIGHTING SYSTEM (AFS) (if equipped)

*The AFS automatically turns the headlight beam to the right or left (in conjunction with the direction of the steering wheel) to improve the direction of headlight illumination while cornering. AFS only works when the vehicle is moving.*

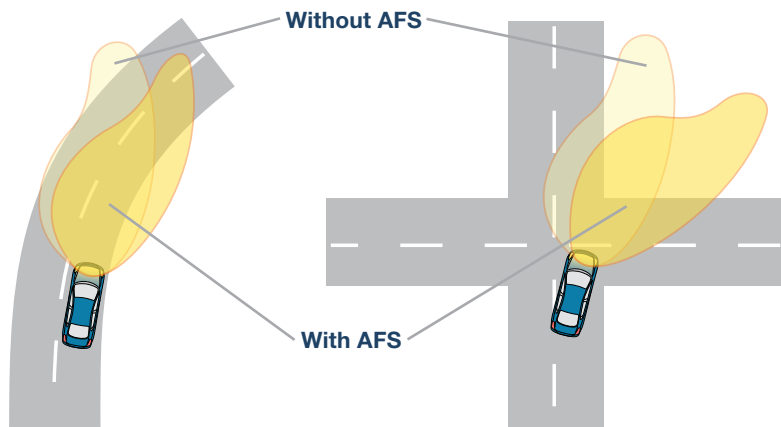

### NOTE:

- With AFS, it is normal to see the headlights move and hear the sound of the headlight leveling motors at the front of the vehicle when the ignition is ON.
- The system will need to be reset if the vehicle battery has been disconnected or the system fuse has been replaced. Refer to your Owner's Manual for easy to follow resetting instructions.



Push AFS OFF to turn system off or on. When off, the AFS OFF indicator in the instrument panel will turn on.

# Manual Climate Control



## TEMPERATURE CONTROL DIAL

Rotate the dial for temperature control.

**NOTE:** When set to MAX A/C with dashboard vents or dashboard and floor vents, the A/C will turn on, and recirculated air will be selected for maximum cooling.

## FAN CONTROL DIAL

Rotate the dial to set desired fan speed.

 Push to recirculate cabin air to reduce outside odors and improve cooling.

 Push for fresh air circulation.

**A/C** Push to manually turn air conditioning on or off.

 Push to defrost the rear window.

## MODE SELECTOR DIAL

Rotate the dial to select airflow mode.

 Dashboard vents

 Dashboard and floor vents

 Floor vents

 Defroster and floor vents

 Windshield defroster

## Best Cooling Settings







**Indicator ON (automatically)**

## Best Heating Settings



## DEFROSTER NOTE:

- When selecting either defroster mode ( or ) , the air conditioner and fresh air mode are automatically turned on by the system. This helps defrost the windows more efficiently by dehumidifying the air. Manually set the fan control and temperature control dials as desired.
- In either defroster mode ( or ) , air will blow from the side dashboard vents. To defrost the side windows faster, point the vents toward the side windows.

# Automatic Climate Control





## DRIVER TEMPERATURE CONTROL DIAL

**AUTO ON:** Push dial to turn automatic Air conditioning system on (indicator light on). Rotate dial to select your desired set temperature (shown above). The airflow mode and the amount of airflow will be automatically controlled in accordance with the set temperature.

## Fan Control

- Push the fan (+) and (-) buttons to select the desired fan speed.
- Push OFF to turn climate control system off.

 Push to recirculate cabin air to reduce outside odors and improve cooling.

 Push for fresh air circulation.

**NOTE:** Automatic climate control will allow you to maintain individual preset cabin temperatures for the driver and passenger when DUAL mode is selected.



Push to select the following airflow mode:

-  Dashboard vents
-  Dashboard and floor vents
-  Floor vents
-  Defroster and floor vents
-  Push to defrost the windshield.

**A/C** Push to manually turn air conditioning on or off.

## PASSENGER TEMPERATURE CONTROL DIAL

Push to turn DUAL mode ON/OFF.

- With DUAL mode ON (indicator on), rotate the dial to set passenger side temperature separate from the driver's side (shown above).
- With DUAL mode OFF (indicator off), driver controls the temperature setting on both sides.

 Push to defrost the rear window.

**NOTE:** Automatic temperature control always works even if the AUTO indicator turns off by changing the fan speed or airflow mode.





# Audio Controls (without Mazda Connect)

## AUDIO CONTROLS



### POWER ON/OFF

Push the POWER/VOL dial.

### MEDIA SELECTION

**FM/AM:** Push FM/AM button to select the FM1, FM2, or AM band. The selected band will be indicated in the display.

**MEDIA:** Push to select Bluetooth, CD, USB, or AUX.

### TUNING

The radio has the following tuning controls:

**Manual:** Lightly push the TUNE arrows to manually change the frequency up or down.

**Seek:** Push and hold the TUNE arrows until a beep is heard to automatically seek a higher or lower frequency with a station.

**Scan:** Push and hold the MEDIA button to automatically sample strong stations for about 5 seconds each. Push again to cancel.

### SETTING THE CLOCK

- 1 Push and hold FM/AM (CLOCK) button until a beep sound is heard. The current time will flash.
- 2 To adjust the time, push (and hold) the Hour or Minute set button (TUNE ◀◀ or ▶▶).
- 3 Push the FM/AM (CLOCK) button again.

**Preset Channel:** Push 1/2/3/4/5/6 button to select a station stored in memory. To store a station, push and hold 1/2/3/4/5/6 until station is displayed.

**Auto Memory Tuning:** Push and hold the AUTO-M button until a beep is heard to store an additional 6 stations with a strong signal on each FM and AM band without disturbing the previously stored stations. To return to the previously stored stations, push FM/AM button. Use this when travelling outside your local area. Refer to the Owner's Manual for complete details.





**NOTE:** To use BT audio, make sure the musical note icon is displayed in the audio display. Some Bluetooth® audio devices need a certain amount of time before the icon is displayed.

**MENU:** Push the MENU button to adjust the audio sound, turn audio operation beep on and off, perform Bluetooth setup, or change the clock between 12 and 24 hr times.

### FOLDER SEARCH (during MP3/WMA/AAC CD or USB playback)

- To change to the previous folder, push the folder down button ▼, or push the folder up button ▲ to advance to the next folder.

### LOADING A CD

- CD player is located just in front of the transmission gear selector (if equipped).
- Insert the CD into the slot, label-side up. The auto loading mechanism will load the CD and begin to play it.



# Audio Controls (with Mazda Connect)

## BLUETOOTH® AUDIO

Bluetooth® enabled phones and audio players provide an opportunity to play music through the audio system with no wires attached.

Some phone models do not support all features. Go to [www.MazdaUSA.com/bluetooth](http://www.MazdaUSA.com/bluetooth) or contact (800) 430-0153 for further assistance or to report a phone /MP3 device concern.

## Playing Bluetooth® (BT) Audio

- 1 Make sure BT audio device is paired to your vehicle.
- 2 Turn on BT audio device.
- 3 Select Bluetooth from Sources.

See your Owner's Manual for further information on:  
· Pandora · Aha · Stitcher



## AUDIO OPERATION

The following icons are displayed on the screen:

 **SOURCES:** Displays Audio menu to change audio source (FM / AM / XM / Aha / Pandora / Stitcher / Bluetooth / USB / CD / AUX).

### NOTE:

-  New Mazda vehicles equipped with SiriusXM® Satellite Radio will receive an introductory subscription with a limited term trial offer to over 150 channels of SiriusXM Satellite Radio. Enjoy commercial-free music, plus sports, news, entertainment, and every premium channel in your vehicle. Call 877-447-0011 to activate. See the Owner's Manual and/or dealer for details.
- In order to use Aha, Pandora and Stitcher as audio sources, the App must be installed on your phone. These Apps stream music using your data plan and listening to them counts towards your monthly cellular data usage.



 **HD RADIO:** Switches HD Radio On/Off.

 **SCAN:** Scans radio stations or songs (scanning stops at each one for 5 seconds). Select again to stop.

 **TUNER:** Displays manual radio tuner.

 **TAG:** Saves artist and title and sends them to your Apple device (for Apple devices with USB use only).

### SEEK PREVIOUS/NEXT:

  Selects previous or next receivable radio station or song. Press and hold to change radio station continually.

 **SETTINGS:** Adjusts the audio quality level (bass, treble, etc.).

The following icons are displayed on the CD screen only:

 **TRACK LIST:** Displays the track list of the CD.

 **REPEAT:** Repeats the current song. Select again to stop.

 **SHUFFLE:** Plays the songs on the CD in random order. Select again to stop.

 **PLAY/PAUSE:** Plays and Pauses the CD.





## GRACENOTE

The Gracenote media database is used to improve voice recognition of artist and album names with the Mazda Hands Free system. To make best use of the voice recognition, install the most recent database.

- 1 Load the Gracenote update on a memory stick from [www.MazdaUSA.com/USB](http://www.MazdaUSA.com/USB). Insert the memory stick into the USB port.
- 2 Go to System Settings in the infotainment system.
- 3 Select Music Database Update.

**NOTE:** To use BT audio, make sure the musical icon is displayed by going to  Bluetooth in Device settings.

Some Bluetooth® audio devices need a certain amount of time before the icon is displayed.



## HD RADIO

HD radio has a special receiver which allows it to receive digital broadcasts (where available) in addition to the analog broadcasts it already receives. Digital broadcasts have better sound quality than analog broadcasts as digital broadcasts provide free, crystal clear audio.

When the HD radio button is ON (red), there could be a noticeable difference in sound quality and volume when a change from digital to analog signals occurs. If the sound quality and volume becomes noticeably diminished or cuts off, select the HD button to turn OFF HD radio (not red).

**NOTE:** Push the TALK button and say "Help" at any time to hear a list of available commands.

## AUDIO OPERATION USING VOICE

Audio operation and media selection can be done using voice. Push the "TALK" button on the steering wheel, wait for a beep, then say a command in a clear, natural voice (not too fast or too slow). Some common commands are listed below.

### Play (and any of the following):

AM, FM, XM, CD, Bluetooth, Aha, Pandora, Stitcher, USB, AUX

### Play or Resume / Pause or Stop / Next or Previous

### Play (and any of the following):

Song, Playlist <playlist name>, Artist <artist name>, Album <album name>, Genre <genre name>, Folder <folder name>

### Tune to Station <frequency AM or FM>

### Tune to Channel Number (XM)

# Audio USB and AUX Inputs

## PORTABLE AUDIO PLAYER INTEGRATION USING THE USB PORT OR AUX JACK

(without CD player) (with CD player)

Your vehicle is equipped with a USB port and auxiliary AUX jack, conveniently located below the climate controls (without CD

player) or in the center console (with CD player), that allows you to play your iPod, USB device, or portable audio player through the vehicle's audio system.

The center console is useful for storing your personal media/phone devices. Learn the system when parked and do not let it distract you while driving.



### IMPORTANT:

- Set the volume level on your portable audio player to the highest level before distortion starts, then use the vehicle's audio system to adjust the volume.
- Unplug any device from the USB port and accessory socket before turning off the vehicle. Leaving devices plugged in can drain the battery and cause issues during the Bluetooth pairing process at startup. Wait about 15 seconds after starting the vehicle before plugging anything into the USB port.

**NOTE:** You will need an audio cable with an 1/8 inch (3.5 mm) mini stereo plug (available as a Genuine Mazda accessory) to connect your portable audio player into the AUX jack.



- 1 Locate the USB port or AUX jack.
- 2 Connect the device plug into the portable audio player and into the USB port or AUX jack.
- 3 Turn the vehicle audio system on.
- 4 • **Audio Controls (without Mazda Connect):** Push the MEDIA button on the audio unit to switch to the AUX or USB mode.  
• **Audio Controls (with Mazda Connect):** Select AUX or USB from the Sources menu.
- 5 • **USB Port:** Use the vehicle's audio system or steering wheel controls to control the connected USB device.  
• **AUX Jack:** Use the portable audio player controls to play music.

Refer to the Owner's Manual for additional information.

**NOTE:** When using a USB memory stick, the system plays the first audio file when restarting the vehicle. It does not start where it left off when turning off the engine.

## 12 VOLT ACCESSORY SOCKETS

The accessory socket in the dash is on with ignition on and the accessory socket in the center console is always on.

**NOTE:** When using the accessory socket in the center console, make sure to disconnect any device from it when turning off the ignition, otherwise the vehicle's battery could go dead.

## i-ELOOP (if equipped)

The Mazda-unique regenerative braking system (i-ELOOP) generates and stores electrical energy in a capacitor during deceleration. Through efficient energy regeneration, storage, and usage, fuel economy is improved. To view i-ELOOP information, select Applications from the Home screen, then scroll down to Fuel Economy Monitor.



Capacitor charge level

Regeneration level



Capacitor discharge

Average fuel consumption since reset



60-minute Fuel Economy

0-10 min.: Every 1 min.

10-60 min.: Every 10 min.

Average fuel consumption for this drive

Average Current Fuel History:

Average since reset 2nd to 6th history

## i-ELOOP Pre-Charge Mode

If the capacitor is discharged because of vehicle storage (the vehicle is parked for long periods of time), the i-ELOOP indicator in the instrument cluster will flash and a warning screen appears on the screen of the infotainment system.

In Pre-charge mode



Driving in Pre-charge mode



When this warning screen appears, do not drive the vehicle. Allow the engine to idle until the warning screen disappears. This time is needed for normal generator operation.

i-ELOOP



### NOTE:

- If the vehicle is jump started, leave the jumper cables connected until the warning message is no longer displayed.
- If the vehicle is driven while the warning screen is displayed, a warning sound will be heard and power steering assist will be limited.





















# Instrument Cluster (Type A)

## OUTSIDE TEMPERATURE DISPLAY

The outside temperature unit can be switched between °C and °F using System Settings in the infotainment system.

## SPEED UNIT SELECTOR<sup>3</sup>

**NOTE:** See Owner's Manual for more details and explanations.

-  **Lane Departure Warning System On (AMBER)/ Lane Detected (GREEN)** (p. 20)
-  **AFS OFF Adaptive Front Lighting System (AFS) OFF** (p. 26)
-  **Traction Control System (TCS)/ Dynamic Stability Control (DSC)**  
On: TCS/DSC malfunction  
Flashing: TCS/DSC operating
-  **BSM OFF (Blind Spot Monitoring)** (p. 21)
-  **Dynamic Stability Control (DSC) Off Indicator Light**
-  **SPORT SPORT Mode On** (p. 39)
-  **Lights On (Exterior)**
-  **High Beam Control On**
-  **Headlight High Beams On**
-  **Air Bag/Front Seat Belt Pretensioner System Malfunction**
-  **Check Engine Light**
-  **Seat Belt Unbuckled/Malfunction**
-  **Turn Signals/Hazard Warning Indicator Lights**
-  **Tire Pressure Monitoring System (TPMS) Warning Light** (p. 7)  
On/Warning BEEP: Low tire pressure in one or more tires. Flashing: TPMS Malfunction
-  **Cruise Main Indicator Light On (AMBER)/Cruise Set Indicator Light On (GREEN)**
-  **Mazda Radar Cruise Control Warning Light On (AMBER) Set Indicator (GREEN)** (pp. 17-18)
-  **ABS (Antilock Brake System) Malfunction**
-  **PRNDM Shift Position Indicator Light**
-  **Security Indicator Light**
-  **Forward Obstruction Warning (FOW) and Smart City Brake System (SCBS)**  
Flashing red: FOW and SCBS are operating.  
Amber: FOW and/or SCBS malfunction.  
OFF: FOW and SCBS are turned off.

**TPMS NOTE:** Low ambient temperature and/or high altitude may cause tire pressures to change and turn the TPMS warning light on. If the warning light comes on, see p. 7.



## DASHBOARD ILLUMINATION/ DIMMER<sup>1</sup>/TRIP METER<sup>2</sup>

## TRIP COMPUTER

The following information can be selected by pushing the ▲ or ▼ of the INFO button on the steering wheel.

- Approximate distance you can travel on the available fuel (RANGE)
- Average fuel economy
- Current fuel economy
- Average vehicle speed
- To reset, push and hold the INFO button for more than 1.5 seconds.



### Brake Warning Light

Parking brake on/low brake fluid/malfunction



### Master Warning Light



### Low Fuel Level



### Low Engine Oil Pressure



### Power Steering Malfunction



### Automatic Transaxle Warning Light



### Charging System Malfunction



### Door/Trunk/Tailgate Ajar



### Low Washer Fluid Level Warning Light



### KEY Warning Light **RED**



### KEY Indicator Light **GREEN**



### Check Fuel Cap



### Perform Maintenance



### i-ELOOP Status (p. 34)

**On:** Power generation

**Flashing:** Pre-Charge Mode

- Rotate the knob to adjust the brightness of the instrument cluster and other dashboard illuminations.
- Push to toggle between trip meter (A & B).
  - When a trip meter is selected, push and hold to reset to zero.
- Push the knob for 1.5 seconds or more to change the speed units between km/h and mph.

## ENGINE COOLANT TEMP LIGHTS

Since this vehicle does not use an engine coolant temperature gauge, red and blue engine coolant temperature lights are used to indicate high and low coolant temperature.



### Red Coolant Temp Light

**Flashing:** Engine is starting to run hot. Drive slowly to reduce engine load.

**On:** Engine is overheating. Safely pull over to the side of the road and turn the engine off. Refer to the Owner's Manual for more information.



### Blue Coolant Temp Light

**On:** Engine coolant is cold and no warm air is available for heater/defroster.

**Off:** Engine coolant is warm and warm air is available for heater/defroster. The light may stay on for a few minutes after start-up when the engine is cold, but the vehicle can be driven with the light on or off.

**NOTE:** The instrument cluster becomes dimmer when the headlights are on. If the illumination is too dim or too bright with the headlights on, simply rotate the knob to adjust the brightness of the illumination.



# Instrument Cluster (Type B)

## OUTSIDE TEMPERATURE DISPLAY

The outside temperature unit can be switched between °C and °F using the following procedure Without Infotainment:

- 1 Push the INFO button with the ignition OFF and continue pressing the INFO button for 5 seconds or longer after switching the ignition ON. The outside temperature display flashes.
- 2 Push the up or down part of the INFO switch to change the temperature unit.
- 3 Push and hold the INFO button for 3 seconds or longer until it stops flashing.

With Infotainment:

- 1 Go to System Settings.



## TACHOMETER

**NOTE:** See Owner's Manual for more details and explanations.



### Traction Control System (TCS)/ Dynamic Stability Control (DSC)

On: TCS/DSC malfunction  
Flashing: TCS/DSC operating



### BSM OFF (Blind Spot Monitoring) (p. 21)



### Dynamic Stability Control (DSC) Off Indicator Light



### SPORT Mode On (p. 39)



### Lights On (Exterior)



### High Beam Control On



### Headlight High Beams On



### Air Bag/Front Seat Belt Pretensioner System Malfunction



### Check Engine Light



### Seat Belt Unbuckled/Malfunction



### Turn Signals/Hazard Warning Indicator Lights



### Tire Pressure Monitoring System (TPMS) Warning Light (p. 7)

On/Warning BEEP: Low tire pressure in one or more tires. Flashing: TPMS Malfunction



### Cruise Main Indicator Light On (AMBER)/Cruise Set Indicator Light On (GREEN)



### ABS (Antilock Brake System) Malfunction



### Shift Position Indicator Light



### Security Indicator Light



### Brake Warning Light

Parking brake on/low brake fluid/malfunction



### Master Warning Light



### Low Fuel Level





**DASHBOARD ILLUMINATION/  
DIMMER<sup>1</sup>/TRIP METER<sup>2</sup>**

## TRIP COMPUTER

The following information can be selected by pushing the ▲ or ▼ of the INFO button on the steering wheel.

- Approximate distance you can travel on the available fuel (RANGE)
- Average fuel economy
- Current fuel economy
- Average vehicle speed
- To reset, push and hold the INFO button for more than 1.5 seconds.



-  **Low Engine Oil Pressure**
-  **Power Steering Malfunction**
-  **Automatic Transaxle Warning Light**
-  **Charging System Malfunction**
-  **Door/Trunk/Tailgate Ajar**
-  **Low Washer Fluid Level Warning Light**
-  **KEY Warning Light RED**
-  **KEY Indicator Light GREEN**
-  **Check Fuel Cap**
-  **Perform Maintenance**

## ENGINE COOLANT TEMP LIGHTS

Since this vehicle does not use an engine coolant temperature gauge, red and blue engine coolant temperature lights are used to indicate high and low coolant temperature.

### Red Coolant Temp Light

**Flashing:** Engine is starting to run hot. Drive slowly to reduce engine load.

**On:** Engine is overheating. Safely pull over to the side of the road and turn the engine off. Refer to the Owner's Manual for more information.

### Blue Coolant Temp Light

**On:** Engine coolant is cold and no warm air is available for heater/defroster.

**Off:** Engine coolant is warm and warm air is available for heater/defroster. The light may stay on for a few minutes after start-up when the engine is cold, but the vehicle can be driven with the light on or off.

**NOTE:** The instrument cluster becomes dimmer when the headlights are on. If the illumination is too dim or too bright with the headlights on, simply rotate the knob to adjust the brightness of the illumination.

- Rotate the knob to adjust the brightness of the instrument cluster and other dashboard illuminations.
- Push to toggle between trip meter (A & B).  
• When a trip meter is selected, push and hold to reset to zero.

## MANUAL SHIFT MODE (if equipped)

**Manual Shift Mode gives you the feel of driving a manual transmission by allowing you to manually shift to control engine rpm and torque when more control is desired.**

### To Use Manual Shift Mode:

- Shift the lever from D to M.

### To Shift Up

#### To A Higher Gear:

- Pull the steering UP switch (+) once or tap the shift lever back (+) once.

### To Shift Down

#### To A Lower Gear:

- Pull the steering DOWN switch (-) once or tap the shift lever forward (-) once.

**NOTE:** Steering Shift Switches can be used in "D" or "M".

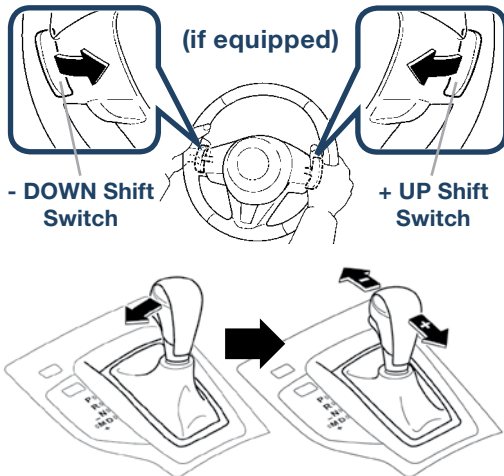

## DRIVE SELECTION (if equipped)

**By selecting Sport mode, greater vehicle response is achieved through automatic adjustments in transmission shift control and engine throttle control. This provides additional quick acceleration which may be needed to safely make maneuvers such as lane changes, merging onto freeways, or passing other vehicles.**

Push the SPORT button to switch to SPORT mode and the SPORT mode indicator light in the instrument cluster turns on. Push again to turn off.



### NOTE:

- If the SET button of the cruise control is pushed while in SPORT mode, SPORT mode is switched off. SPORT mode cannot be turned on or off when cornering.
- When the ignition is switched off, SPORT mode is also switched off.
- Fuel consumption increases slightly when using SPORT mode.



## ACTIVE ADAPTIVE SHIFT (AAS) CONTROL

**AAS will automatically adjust how and when the transmission shifts gears based on road conditions and your driving style. The transmission may stay in a lower gear longer than usual when going up or down hills or driving around corners. This feature gives you better control and a more connected driving experience.**

## ACCELERATOR PEDAL KICKDOWN SWITCH\*

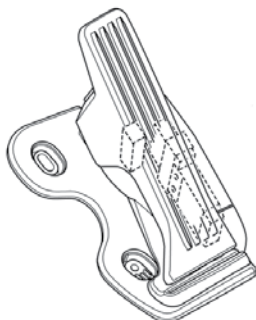

**The accelerator pedal is equipped with a kickdown switch designed to allow optimal engine performance while accelerating.**

When you depress the accelerator 95% of the way, you will feel an increase in resistance. Push harder, and you will feel a click as you activate the kickdown switch. The transmission will usually downshift (depending on engine speed) and the engine will switch to maximum power mode. This kickdown switch function is the same in both Manual mode and in "D".

*\*Available on vehicles with automatic transmission only.*

## HILL LAUNCH ASSIST (HLA)

**HLA helps assist you when accelerating the vehicle from a stop while on a hill or slope.**

When the brake pedal is released and the accelerator pedal is pushed, HLA prevents the vehicle from rolling forward or backward. It operates on a downward slope when the shift lever is in the reverse (R) position, and on an upward slope when the shift lever is in a position other than the reverse (R) position.

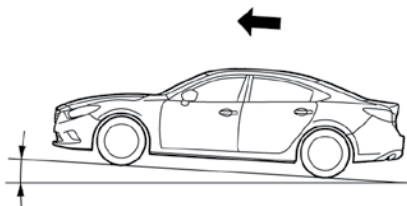

**IMPORTANT:** The HLA system will hold the vehicle for a maximum of 2.0 seconds while the driver is changing from the brake pedal to the accelerator pedal.

# Cupholders

**The Mazda3 is equipped with cup holders and bottle holders conveniently located throughout the cabin.**



The rear cup holders are located on the rear center armrest.

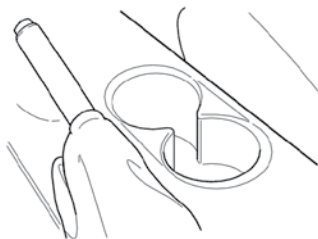

The front cup holders are located in the center console behind the shifter and commander switch (if equipped).

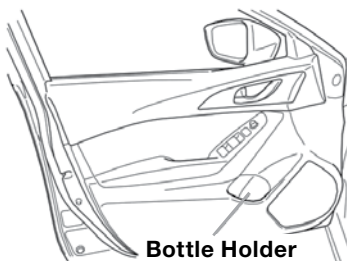

**Bottle Holder**

Bottle holders are located on the inside of the doors.

## STORAGE

**The Mazda3 is equipped with several storage locations:**

- Glovebox
- Center Console (including storage tray)
- Door Pockets

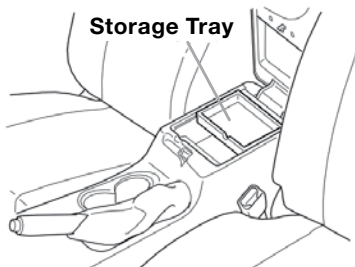

**Storage Tray**





## PERSONALIZE YOUR MAZDA3 WITH GENUINE MAZDA ACCESSORIES

Go to [www.MyMazda.com](http://www.MyMazda.com), then select “Accessories” below the MyMazda Home header for a complete listing of available accessories for your Mazda3.

## *WWW.MYMAZDA.COM—THE OFFICIAL SITE FOR MAZDA OWNERS*

Register today on [www.MyMazda.com](http://www.MyMazda.com)—the ultimate destination for Mazda Owners. Once registered, you’ll be able to take advantage of benefits exclusively for Mazda Owners:

- Insider access to exclusive events and promotions
- Personalized maintenance schedules
- Zoom-Zoom Owner Magazine
- Warranty information and on-line Owner’s Manuals
- Wallpaper, videos and other fun stuff
- Accessories specifically designed for your vehicle
- Car Care Discount Coupons available from your Authorized Mazda Dealer

Visit and register at [www.MyMazda.com](http://www.MyMazda.com) today!

## MAZDA MOBILE

The following apps are available for iPhone® and Android smartphones:

- **Mazda Assist app** - Provides roadside assistance 24 hours a day, 365 days a year. Toll free number 1-800-866-1998 can also be used for roadside assistance.
- **MyMazda app** - Keep track of your Mazda from the palm of your hand with these features:
  - Maintenance schedule
  - Service coupons
  - Promotional alerts
  - Service history
  - Recall information
  - Parked car locator
  - Scan VIN barcode capability when registering a vehicle
  - Mazda Dealer locator
  - Update owner profile
  - Link to Mazda Assist

The apps can be downloaded, free of charge, from the App store for the iPhone® and Google Play (Android Market) for Android powered devices. After downloading app, customer name, email, smartphone number and VIN are required.



**Free Mazda Assist app**  
iPhone and Android



**Free MyMazda app**  
iPhone and Android

# Customer Delivery Checklist

## VEHICLE PRESENTATION:

Refer to the Smart Start Guide during presentation

<b>ESSENTIAL INFORMATION</b>	<input type="checkbox"/> <b>Driver's View</b> .....1	<b>SAFETY &amp; TECHNOLOGY INFORMATION</b>	<input type="checkbox"/> <b>Active Driving Display*</b> .....15
	• Location of Switches and Control		<input type="checkbox"/> <b>Mazda Connect Settings*</b> .....16
	<input type="checkbox"/> <b>Keyless Entry</b> .....3		<input type="checkbox"/> <b>Mazda Radar Cruise Control*</b> ...17
	<input type="checkbox"/> <b>Advanced Keyless Entry*</b> .....4		<input type="checkbox"/> <b>Forward Obstruction Warning*</b> ...18
	• Door Request Switch*		<input type="checkbox"/> <b>Smart City Brake Support*</b> .....19
	<input type="checkbox"/> <b>Starting the Engine</b> .....5		<input type="checkbox"/> <b>Lane Departure Warning System (LDWS)*</b> .....20
	• Accelerated Warm-Up System (AWS)		<input type="checkbox"/> <b>Blind Spot Monitoring*</b> .....21
	• Push Button Start System		<input type="checkbox"/> <b>Rear Cross Traffic Alert*</b> .....22
	• Emergency Vehicle Entry/ Engine Start/Stop		<input type="checkbox"/> <b>High Beam Control*</b> .....25
	<input type="checkbox"/> <b>Break In Period</b> .....6		<input type="checkbox"/> <b>Adaptive Front Lighting System (AFS)*</b> .....26
	<input type="checkbox"/> <b>Fuel Economy</b> .....6		<input type="checkbox"/> <b>Lights</b> .....23
	<input type="checkbox"/> <b>Tire Pressure Monitor System</b> ....7		<input type="checkbox"/> <b>Wiper/Washer</b> .....24
	• Initialize TPMS before delivery		<input type="checkbox"/> <b>Climate Control</b> .....27
<input type="checkbox"/> <b>Seats and Headrests</b> .....8	<input type="checkbox"/> <b>Audio Controls</b> .....29		
<input type="checkbox"/> <b>Mazda Connect*</b> .....9	• Bluetooth Audio		
<input type="checkbox"/> <b>Commander / Voice Control*</b> ...10	<input type="checkbox"/> <b>Set Clock</b> .....29		
<input type="checkbox"/> <b>Bluetooth®*</b> .....11	<input type="checkbox"/> <b>Audio USB &amp; AUX Inputs</b> .....33		
• Pair Phone	<input type="checkbox"/> <b>i-ELOOP*</b> .....34		
• Make/Receive Call	<input type="checkbox"/> <b>Instrument Cluster</b> .....35		
• Toll-Free Customer Service <b>800-430-0153</b>	• Review of Warning and Indicator Light Function and Location		
<input type="checkbox"/> <b>Navigation System*</b> .....13	<input type="checkbox"/> <b>Transmission</b> .....39		
• SD Card	<input type="checkbox"/> <b>Cupholders/Storage</b> .....41		
• Planning a Route			

\*if equipped

## SCHEDULED MAINTENANCE:

When replacing or topping off engine oil, use Mazda Genuine oil. For optimal engine performance, use SAE 0W-20 engine oil. Please consult an Authorized Mazda Dealer for additional information.

**All items in the Customer Delivery Checklist have been reviewed with the customer and the first maintenance appointment has been scheduled:**

SALES CONSULTANT	DATE	CUSTOMER	DATE

Signed copy must be placed in dealer jacket.

# Customer Delivery Checklist

<b>DEALERSHIP</b>	<b>DATE</b>
<b>SALES CONSULTANT</b>	<b>CUSTOMER'S NAME</b>
<b>VIN</b>	<b>E-MAIL</b>

## PRESENTATION OF OWNER'S MATERIALS:

*Review the following items with the customer*

### Smart Start Guide

- Remove this checklist from Smart Start Guide
- Personalization Features (refer to your Owner's Manual)

### Warranty Information

**Warranty Start Date:** \_\_\_\_\_

**Customer Initial:** \_\_\_\_\_

- Basic Vehicle – 36 months/36,000 miles
- Roadside assistance program

### [www.MyMazda.com](http://www.MyMazda.com)

- Offer to register customer on [www.MyMazda.com](http://www.MyMazda.com)

### Owner's Manual

## SERVICE DEPARTMENT

- Introduce Service Manager; provide business cards
- Review Service and Parts Department hours of operation
- Explain free Full Circle Service Inspection
- Schedule first maintenance service

### Maintenance Passport

#### Floor Mats

- Ensure floor mats are properly hooked after cleaning
- Do not install two floor mats, one on top of the other, on the driver side
- Accessory rubber floor mats should be cleaned with mild soap and water only

#### Tire Pressure Monitoring System

- System overview
- Demonstrate how to initialize the TPMS system
  - Push and hold the "SET switch" until the TPMS warning light flashes twice and one beep is heard
- Review the system Caution





## GENUINE MAZDA SERVICE

***Because you and your Mazda deserve the best***

Your new Mazda deserves nothing less than the very best. To keep it running like new for years to come, trust the experts at your local Authorized Mazda Dealer. Simply bring your vehicle in for your scheduled maintenance and any needed repairs.\*

At participating Mazda Full Circle Service Centers,\*\* our technicians will automatically perform a complimentary Full Circle inspection on your vehicle and issue a detailed report card at every visit. This is designed to help you keep track of your Mazda's critical operating condition. Our factory-trained technicians know your vehicle inside out and use Genuine Mazda Parts, giving your vehicle the optimum care and maintenance it requires to run with flawless precision.

Remember, to further enhance your driving experience, visit your local Mazda Service Center for your scheduled maintenance. It's also the place where you can find a wide variety of tires, parts, and accessories that are just right for your vehicle.

\* See vehicle's scheduled-maintenance program for details.

\*\* Visit the Mazda Owners website at [www.MyMazda.com/fullcircle](http://www.MyMazda.com/fullcircle) to find a participating Mazda Full Circle Service Dealer.

Customer Experience Center: 1-800-222-5500

Roadside Assistance Contact: 1-800-866-1998

*Mazda*  
**FULL CIRCLE**  
*SERVICE*

**FREE FULL CIRCLE  
SERVICE INSPECTION**

*We're committed to providing  
expert Mazda service.*

You love to drive your Mazda, and we love to service your Mazda. With our Full Circle Service, we'll give your vehicle a COMPLIMENTARY MULTI-POINT INSPECTION. Your Mazda will receive a thorough review of its most crucial components.

This easy-to-use Smart Start Guide is intended to help you more fully appreciate some of the unique features and functions of your new vehicle. However, it is not intended to replace your Owner's Manual. The Owner's Manual contains more detailed information to help you better understand the important safety warnings, features, operation, and maintenance of your vehicle. All information, specifications, photographs and illustrations in this publication are those in effect at the time of printing. Mazda reserves the right to change specifications or design without obligation.

© Mazda North American Operations  
Printed in U.S.A. 04/14  
Print 6  
9999 95 038C 14SS



[www.MazdaUSA.com](http://www.MazdaUSA.com)